





With logo Gri, born two twins companies, whose mission is to develop and produce innovative accessories for inflatable field. The most important mission that we have set is the satisfaction of our customers: not only to supply high-quality innovative products, but also to offer a service rapid and precise.

The brand GRI, besides supplying directly to the major part of inflatable items factory in China, export also his products to more than 30 nations. The new 4500m<sup>2</sup> operative site locates in Sanqishi Town-Yuyao, which can be achieved in 30 minutes from Ningbo airport and in 2 hours from Shanghai airport.

伴随着GRI这个商标，诞生了两家姊妹公司。其使命是为充气行业开发及生产具有创新性的配件。其中最重要的使命是满足我们的客户：不仅仅是提供高质量，有创新性的产品，还要提供快速、精确的服务。

品牌GRI，除了直接供给到中国大部分充气行业的厂家外，还出口到30多个国家和地区。新的4500平方米的厂房坐落在余姚三七市镇，离宁波机场有30分钟车程，离上海机场为2小时车程。

Ningbo Jing Quan Import&Export Co.,Ltd.  
宁波景铨进出口有限公司

Yuyao Ermanno Plastic Technology Co.,Ltd.  
余姚爱玛诺塑料科技有限公司

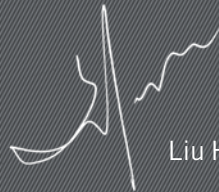

Liu Huan (Nolan)





## INDEX

HP8 HIGH PERFORMANCE hand pump for SUP board 6

HP9 HIGH PERFORMANCE hand pump for SUP board 7

HP5 hand pump for BIG SUP board TRIPLE ACTION 8

HP6 hand pump for BIG SUP board TRIPLE ACTION 9

HP2 hand pump for SUP board DOUBLE ACTION 10

HP2-R hand pump for SUP board DOUBLE ACTION 11

HP10 / HP10-R  
hand pump for SUP board DOUBLE ACTION REMOVABLE FOOT 12

HP7 / HP7-R  
hand pump for SUP board DOUBLE ACTION REMOVABLE FOOT 13

HP2-B BASIC hand pump for SUP board DOUBLE ACTION 14

Adapters 15

Special accessories for pumps 15

HP1 hand pump for KITE surf DOUBLE ACTION 16

HP3 hand pump for BIG KITE surf DOUBLE ACTION 17

HP4 hand pump for BIG KITE surf TRIPLE ACTION 18

Special action switch 19

Special version handle 19

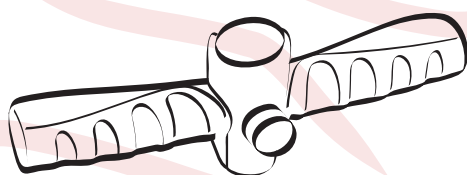
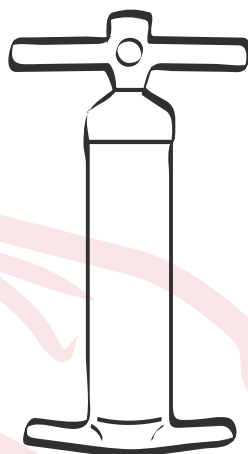
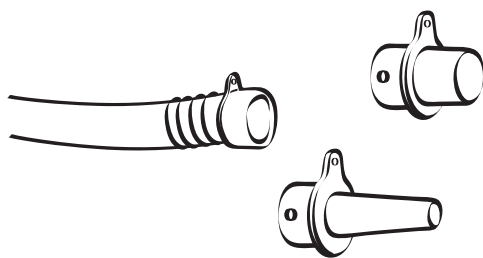
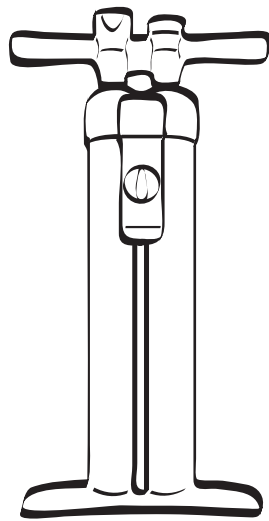

## INDEX

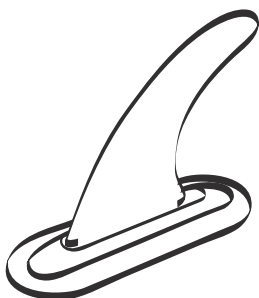
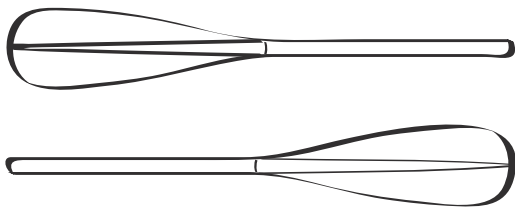
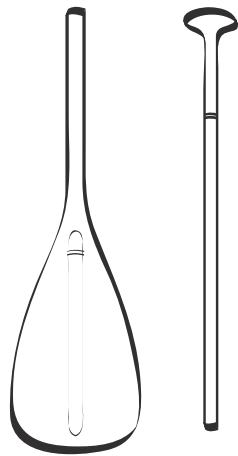

PS1	ALU telescopic SUP paddle	20
PS3	ALU telescopic SUP paddle KIDS	20
PS2	ALU telescopic SUP/KAYAK paddle - COMBO	21
PSG	FIBER telescopic SUP paddle	21
PS5	ALU telescopic SUP paddle	22
PS6	ALU telescopic SUP paddle KIDS	22
PS7	ALU telescopic SUP/KAYAK paddle - COMBO	23
PSH	FIBER telescopic SUP paddle	23
PS8	BASIC ALU telescopic SUP paddle	24
PS9	BASIC ALU telescopic SUP/KAYAK paddle - COMBO	24

GM1	gauge meter adapter	25
		25

RV1	relief valve	
V1	boat valve	26
V4	boat valve	26
V3	SUP valve	27
V5	SUP valve	27
V6	SUP valve	28
KEY2	key for valve	28
V2	KITE surf valve	29
KEY1	key for valve	29

FN1	removable fin	30
FN4	removable fin	30

# HP8

HIGH PERFORMANCE  
hand pump for SUP board

PATENTED

From the five-year experience gained with HP2, we projected HP8 which is the most powerful single-barrel/double-action pump of GRI family. The bigger capacity, the very high efficiency and the ergonomics of this pump make it possible to inflate big RACE boards in a short time & less effort.

根据从五年生产HP2得来的经验，我们设计了HP8，是GRI单筒/双向气泵家族中最强劲的一款。更大的气流量，很高的效率以及他的人体工程学设置，使得在短时间少损耗的情况下充大型的竞赛板成为现实。

## Features:

- capacity 2.0+2.0L, max. pressure 26psi as DIN EN 16051
- handle super ergonomic
- rotating switch for double/single action
- rotating pump adapter to make it easier to connect the hose
- seals and anti-sand filter for long life of pump and SUP board
- high-airflow piston for an easier inflation
- shockproof gauge meter

For adapters available, please see page 15.

## 特性:

- 2.0+2.0L的气流量，根据标准DIN EN 16051测试最高压力为26psi
- 更符合人体工程学的手把
- 转动转换气泵的双/单向工作
- 可旋转接头使得气管连接更容易
- 垫圈及防沙滤网均保证气泵和SUP板的寿命更长
- 大流量的活塞保证了一个更轻松的充气过程
- 防爆压力表

可配接头请见第15页。



# HP9

HIGH PERFORMANCE  
hand pump for SUP board

PATENTED

HP9 is the twin of HP8 and it's projected for big boards which do not require high pressure. The bigger capacity, the very high efficiency and the ergonomics of this pump allow to inflate the big boards in a short time & less effort.

HP9是HP8的姐妹款，是为了大型却不需要很高压力的板子设计的。更大的气流量，很高的效率以及他的人体工程学设置，使得在短时间少损耗的情况下充大型板成为现实。

## Features:

- capacity 2.6+2.6L, max. pressure 20psi as DIN EN 16051
- handle super ergonomic
- rotating switch for double/single action
- rotating pump adapter to make it easier to connect the hose
- seals and anti-sand filter for long life of pump and SUP board
- high-airflow piston for an easier inflation
- shockproof gauge meter

For adapters available, please see page 15.

## 特性:

- 2.6+2.6L的气流量，根据标准DIN EN 16051测试最高压力为20psi
- 更符合人体工程学的手把
- 转动转换气泵的双/单向工作
- 可旋转接头使得气管连接更容易
- 垫圈及防沙滤网均保证气泵和SUP板的寿命更长
- 大流量的活塞保证了一个更轻松的充气过程
- 防爆压力表

可配接头请见第15页。



# HP5 hand pump for BIG SUP board

## TRIPLE ACTION

**TRIPLE ACTION** **PATENTED**

To complete our hand pump range for SUP, we invented the first TRIPLE action pump! HP5 combines an huge capacity of inflation and an extreme ease to achieve high pressures, it's designed to inflate BIG SUP and popular multi persons SUP. HP5, being used in TRIPLE-double-single action, can achieve 26psi rapidly and effortlessly. The switching 3-2-1 can be realized easily and comfortably rotating the switch knob. It's completely customizable for color, graphic and calibration of gauge meter.

为了使我们充SUP的手拉气泵产品线更完整，我们开发了首款三相气泵！HP5，既有巨大的气流量，还能轻松地达到高压，主要为大型SUP及流行的多人SUP设计。HP5可以三向-双向-单向使用，轻松快速地达到26psi。开关3-2-1的调节可以轻松简便地通过转动开关来实现。颜色，压力表的图像及量程完全可以按照要求定制。

### Features:

- capacity 3.5+3.5L, max. pressure 26psi as DIN EN 16051
- switch to change comfortably from triple to double or single
- seals and anti-sand filter for long life of pump and SUP
- extra long body and high-airflow piston for an easier inflation
- shockproof gauge meter

For adapters available, please see page 15.

### 特性:

- 3.5+3.5L的气流量，根据标准DIN EN 16051测试最高压力为26psi
- 舒适切换三向-双向-单向的开关
- 垫圈及防沙滤网均保证气泵和SUP板的寿命更长
- 特别高的气泵及大流量的活塞保证了一个更轻松的充气过程
- 防爆压力表

可配接头请见第15页。





# HP6

hand pump for BIG SUP board  
TRIPLE ACTION

**TRIPLE ACTION** PATENTED

HP6 is the twin of HP5, but it's more compact and light. It's the best for brands who want to use a pump of triple action as standard equipment in their SUP. The compact piston permits also females and young guys to be able to achieve easily high pressure. HP6, being used in TRIPLE-double-single action, can achieve 30psi rapidly and effortlessly. The switching 3-2-1 can be realized easily and comfortably rotating the switch knob. It's completely customizable for colour, graphic and calibration of gauge meter.

HP6是HP5的姐妹款，但是更小更轻。有品牌如需要将三相气泵作为SUP的标配产品的话，这是一个最佳选择。小直径的活塞让女性或小孩也能轻松将板子打到高压。HP6可以三向-双向-单向使用，轻松快速地达到30psi。开关3-2-1的调节可以轻松简便地通过转动开关来实现。颜色，压力表的图像及量程完全可以按照要求定制。

## Features:

- capacity 3.2+3.2L, max. pressure 30psi as DIN EN 16051
- switch knob to change comfortably from triple to double or single
- seals and anti-sand filter for long life of pump and SUP
- extra long body and high-airflow piston for an easier inflation
- pump completely shock-proof, compact and light (1.7kg)
- shockproof gauge meter

For adapters available, please see page 15.

## 特性:

- 3.2+3.2L的气流量，根据标准DIN EN 16051测试最高压力为30psi
- 舒适切换三向-双向-单向的开关
- 垫圈及防沙滤网均保证气泵和SUP板的寿命更长
- 特别高的气泵及大流量的活塞保证了一个更轻松的充气过程
- 气泵防爆，体积小，重量轻（1.70kg）
- 防爆压力表

可配接头请见第15页。



# HP2

hand pump for SUP board  
DOUBLE ACTION

PATENTED

The modern SUP board must be inflated to very high pressure to get optimum performance. For this reason we decided to realize a hand pump more comfortable, rapid and robust. HP2 being used in double action and then single action, can achieve 26psi rapidly and effortlessly. It's completely customizable for color, graphic and calibration of gauge meter.

现代的SUP板都需要充到一个非常高的压力以获得最佳性能。为此，我们决定实现一款舒适，快速并且强大的手打气泵。HP2可以先双向使用，然后单向，这样可以轻松快速地达到26psi。颜色，压力表的图像及量程完全可以按照要求定制。

## Features:

- capacity 1.8+1.8L, max. pressure 26psi as DIN EN 16051
- rotating pump adapter to make it easier to connect the hose
- seals and anti-sand filter for long life of pump and SUP board
- high-airflow piston for an easier inflation
- switch tap for double/single action
- shockproof gauge meter

For special version please see page 19.

For adapters available, please see page 15.

## 特性:

- 1.8+1.8L的气流量，根据标准DIN EN 16051测试最高压力为26psi
- 可旋转接头使得气管连接更容易
- 垫圈及防沙滤网均保证气泵和SUP板的寿命更长
- 大流量的活塞保证了一个更轻松的充气过程
- 旋塞转换气泵的双/单向工作
- 防爆压力表

特殊版本请见第19页。

可配接头请见第15页。



# HP2-R

hand pump for  
SUP board  
DOUBLE ACTION

PATENTED

HP2-R is the twin of HP2, but with the rotating single/double action switch. HP2-R being used in double action and then single action, can achieve 26psi rapidly and effortlessly. It's completely customizable for color, graphic and calibration of gauge meter.

HP2-R是HP2的姐妹款，但是单双向转换接头是转动款。HP2-R可以先双向使用，然后单向，这样可以轻松快速地达到26psi。颜色，压力表的图像及量程完全可以按照要求定制。

## Features:

- capacity 1.8+1.8L, max. pressure 26psi as DIN EN 16051
- rotating pump adapter to make it easier to connect the hose
- seals and anti-sand filter for long life of pump and SUP board
- high-airflow piston for an easier inflation
- rotating switch for double/single action
- shockproof gauge meter

For special version please see page 19.

For adapters available, please see page 15.

## 特性:

- 1.8+1.8L的气流量，根据标准DIN EN 16051测试最高压力为26psi
- 可旋转接头使得气管连接更容易
- 垫圈及防沙滤网均保证气泵和SUP板的寿命更长
- 大流量的活塞保证了一个更轻松的充气过程
- 转动转换气泵的双/单向工作
- 防爆压力表

特殊版本请见第19页。

可配接头请见第15页。



# HP10 HP10-R

hand pump for  
SUP board  
DOUBLE ACTION  
REMOVABLE FOOT

PATENTED

The same character of pump HP2 or HP2-R, but with removable foot in order that it can be inserted into your SUP bag more easily. It's completely customizable for colour, graphic and calibration of gauge meter.

性能和HP2及HP2-R相同，但是底座可拆卸，这样将气泵放入您的SUP包内的时候更方便。气泵颜色，压力表图案量程均可定制。

## Features:

- removable foot
- capacity 1.8+1.8L, max. pressure 26psi as DIN EN 16051
- rotating pump adapter to make it easier to connect the hose
- seals and anti-sand filter for long life of pump and SUP board
- high-airflow piston for an easier inflation
- switch tap or rotating switch for double/single action
- shockproof gauge meter

For special version please see page 19.

For adapters available, please see page 15.

## 特性:

- 底座可拆卸
- 1.8+1.8L的气流量，根据标准DIN EN 16051测试最高压力为26psi
- 可旋转接头使得气管连接更容易
- 垫圈及防沙滤网均保证气泵和SUP板的寿命更长
- 大流量的活塞保证了一个更轻松的充气过程
- 旋塞或可转动旋钮转换气泵的双/单向工作
- 防爆压力表

特殊版本请见第19页。

可配接头请见第15页。



# HP7 HP7-R

MINI hand pump for  
SUP board  
DOUBLE ACTION

PATENTED

The same character of pump HP2 or HP2-R, but more compact: its total height is 505mm. It's completely customizable for colour, graphic and calibration of gauge meter.

性能和HP2及HP2-R相同，但是更小：总高度为505mm。气泵颜色，压力表图案量程均可定制。

## Features:

- capacity 1.3+1.3L, max. pressure 26psi as DIN EN 16051
- rotating pump adapter to make it easier to connect the hose
- seals and anti-sand filter for long life of pump and SUP board
- high-airflow piston for an easier inflation
- switch tap or rotating switch for double/single action
- shockproof gauge meter

For special version please see page 19.

For adapters available, please see page 15.

## 特性:

- 1.3+1.3L的气流量，根据标准DIN EN 16051测试最高压力为26psi
- 可旋转接头使得气管连接更容易
- 垫圈及防沙滤网均保证气泵和SUP板的寿命更长
- 大流量的活塞保证了一个更轻松的充气过程
- 旋塞或可转动旋钮转换气泵的双/单向工作
- 防爆压力表

特殊版本请见第19页。

可配接头请见第15页。



# HP2-B

BASIC hand pump for  
SUP board  
DOUBLE ACTION

PATENTED

HP2-B is the BASIC version of HP2. It's available only in colour BLACK. The graphic and calibration of gauge meter can be personalized.

HP2-B是HP2的基础款。可选择的颜色仅有黑色。图案和压力表量程可按要求定制。

## Features:

- capacity 1.8+1.8L, max. pressure 26psi as DIN EN 16051
- high-airflow piston for an easier inflation
- switch tap for double/single action
- shockproof gauge meter

For adapters available, please see page 15.

## 特性:

- 1.8+1.8L的气流量，根据标准DIN EN 16051测试最高压力为26psi
- 大流量的活塞保证了一个更轻松的充气过程
- 旋塞转换气泵的双/单向工作
- 防爆压力表

可配接头请见第15页。



Adapters available for KITE surf



55106



55133



55107



55104 BLACK



55104 RED



for BOSTON valve

for PVC valve

for V4, V5, V6, HR and Korea valve

for V1, V2 & V3 valve

55108



55129



55130



55134



for special valve

Adapters available for SUP

55115 BLACK



55115 RED



55132



for V4, V5, V6, HR and Korea valve

for V1, V2&V3 valve

for C7&D7 valve

Special accessories for pumps



In this zone the leash is inserted itself and sewed

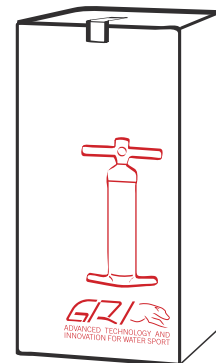

HP1: 280x120x515 mm  
HP2: 280x110x625 mm  
HP3: 280x120x625 mm

Special leash and hook for KITE  
风筝用特殊绳子及钩子

Mesh bag or nylon bag customizable  
可定制网袋或尼龙袋

Color box customizable  
可定制彩盒

# HP1

hand pump for KITE surf  
DOUBLE ACTION

PATENTED

Inflating the kite makes kitesurfers suffer before having fun. For this reason we decided to realize a hand pump more comfortable, rapid and robust. HP1 being used in double action and then single action, can achieve 13psi rapidly and effortlessly. It's completely customizable for color, graphic and calibration of gauge meter.

在开始愉快的风筝之旅之前，给风筝充气总是让风筝玩家感到痛苦。为此，我们决定实现一款舒适，快速并且强大的手打气泵。HP1可以先双向使用，然后单向，这样可以轻松地快速达到13psi。颜色，压力表的图像及量程完全可以按照要求定制。

## Features:

- capacity 2.3+2.3L, max. pressure 13psi as DIN EN 16051
- seals and anti-sand filter for long life of pump and kite
- longer body and high-airflow piston for an easier inflation
- switch tap for double/single action
- shockproof gauge meter

For special version please see page 19.

For adapters available, please see page 15.

## 特性:

- 2.3+2.3L的气流量，根据标准DIN EN 16051测试最高压力为13psi
- 垫圈及防沙滤网均保证气泵和风筝的寿命更长
- 更高的气泵及大流量的活塞保证了一个更轻松的充气过程
- 旋塞转换气泵的双/单向工作
- 防爆压力表

特殊版本请见第19页。

可配接头请见第15页。





# HP3 hand pump for BIG KITE surf

## DOUBLE ACTION

PATENTED

This pump is designed specifically for big kite surf and kite schools. The huge capacity of inflation and the extra tall body allow an comfortable inflation of big kites. HP3 being used in double action and then single action, can achieve 13psi rapidly and effortlessly. It's completely customizable for color, graphic and calibration of gauge meter.

这款手打气泵专门为大型风筝及风筝学校而设计。巨大的气流量及更高的筒身保证了一个更舒适的充大型风筝的充气过程。HP3可以先双向使用，然后单向，这样可以轻松快速地达到13psi。颜色，压力表的图像及量程完全可以按照要求定制。

### Features:

- capacity 2.9+2.9L, max. pressure 13psi as DIN EN 16051
- seals and anti-sand filter for long life of pump and kite
- extra long body and high-airflow piston for an easier inflation
- switch tap for double/single action
- shockproof gauge meter

For special version please see page 19.

For adapters available, please see page 15.

### 特性:

- 2.9+2.9L的气流量，根据标准DIN EN 16051测试最高压力为13psi
- 垫圈及防沙滤网均保证气泵和风筝的寿命更长
- 特别高的气泵及大流量的活塞保证了一个更轻松的充气过程
- 旋塞转换气泵的双/单向工作
- 防爆压力表

特殊版本请见第19页。

可配接头请见第15页。



# HP4 hand pump for BIG KITE surf

## TRIPLE ACTION

**TRIPLE ACTION** **PATENTED**

To complete our hand pump range for KITE surf, we invented the first TRIPLE action pump! HP4 combines an huge capacity of inflation and an extreme ease to achieve high pressures, it's designed to inflate BIG KITE surf or boat, tents etc.

HP4, being used in TRIPLE-double-single action, can achieve 13psi rapidly and effortlessly. The switching 3-2-1 can be realized easily and comfortably rotating the switch knob. It's completely customizable for color, graphic and calibration of gauge meter.

为了使我们充风筝的手拉气泵产品线更完整，我们开发了首款三相气泵！HP4，既有巨大的气流量，还能轻松地达到高压，主要为大型风筝或船，帐篷等设计。

HP4可以三向-双向-单向使用，轻松快速地达到13psi。开关3-2-1的调节可以轻松简便地通过转动开关来实现。颜色，压力表的图像及量程完全可以按照要求定制。

### Features:

- capacity 5.5+5.5L, max. pressure 13psi as DIN EN 16051
- switch to change comfortably from triple to double or single
- seals and anti-sand filter for long life of pump and kite
- extra long body and high-airflow piston for an easier inflation
- shockproof gauge meter

For adapters available, please see page 15.

### 特性:

- 5.5+5.5L的气流量，根据标准DIN EN 16051测试最高压力为13psi
- 舒适切换三向-双向-单向的开关
- 垫圈及防沙滤网均保证气泵和风筝的寿命更长
- 特别高的气泵及大流量的活塞保证了一个更轻松的充气过程
- 防爆压力表

可配接头请见第15页。



# HP1-3/R

SPECIAL ACTION SWITCH

PATENTED

New patented top cap with switch single-double action. Intuitive, rapid and robust use. With filter integrated.

新的专利过的单双向转换旋钮上盖。清晰，快速使用并且牢固。滤网内嵌。

HIGH PRESSURE

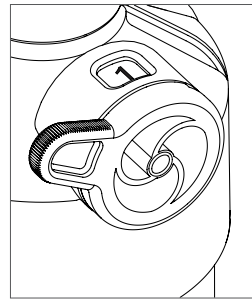

HIGH CAPACITY

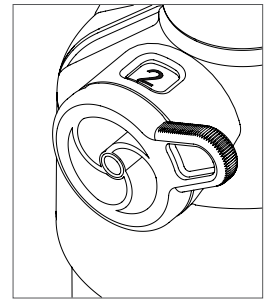

# HP1-2-3-7-10

SPECIAL VERSION HANDLE

		STANDARD version	SPECIAL version
 <p>Handle with screw connect. 螺纹式连接手把</p>		HP1	HP1-S
		HP3	HP3-S
 <p>Handle with function INFLATE-DEFLATE. Bayonet connect. 带有充放气功能手把。 卡口式连接</p>		HP1	HP1-D
		HP3	HP3-D
 <p>Handle with function INFLATE-DEFLATE. Screw connect. 带有充放气功能手把。 螺纹式连接</p>		HP1	HP1-SD
		HP2	HP2-D
		HP3	HP3-SD
		HP7	HP7-D
		HP10	HP10-D

# PS1

ALU telescopic SUP paddle

PATENTED

Telescopic paddle in aluminum shaft with blade injected with gas assist injection which permits to have a rigidity and a low weight. The shaft is in aluminum and anodized in natural color, it's possible to make the shaft in black anodizing. Blade in reinforced polypropylene. It's possible to have blade color personalized.

铝桨杆伸缩桨，使用气辅成型科技注塑而成的桨叶既保证了坚硬度也保证了一个较轻的重量。桨杆是自然色氧化铝管，可以按照要求做成黑色氧化。桨叶由增强聚丙烯制成。可以按照要求定制桨叶颜色。

## Features:

- adjustable length from 153 to 218cm
- light and FLOATING, 1130g
- shaft of 31 and 28mm in alloy 6005-T6
- compact: removable in 3 parts of 79cm

## 特性:

- 长度可在153到218cm之间调节
- 重量轻且上浮，1130g
- 桨杆由31及28mm的6005-T6铝杆组成
- 紧凑：可拆卸成3截，总长79cm



Blade  
675 cm<sup>2</sup>

# PS3

ALU telescopic SUP paddle  
KIDS

PATENTED

Telescopic paddle in aluminum shaft for kids, with the same technical features of PS1.

儿童用铝桨杆伸缩桨，技术特点同PS1

## Features:

- adjustable length from 133 to 185cm
- light and FLOATING, 1030g
- shaft of 31 and 28mm in alloy 6005-T6
- compact: removable in 3 parts of 68cm

## 特性:

- 长度可在133到185cm之间调节
- 重量轻且上浮，1030g
- 桨杆由31及28mm的6005-T6铝杆组成
- 紧凑：可拆卸成3截，总长68cm



# PS2

ALU telescopic  
SUP/KAYAK paddle - COMBO

PATENTED

Same features as paddle PS1, but with an addition blade in order to transform it to KAYAK paddle. The length transforming into KAYAK is 198cm and the blade can be rotated 360°.

特性同PS1桨，但是多一个桨叶，以便于转换成皮划艇桨。转换成皮划艇桨后的长度是198cm，桨叶可以360°旋转。



# PSG

FIBER telescopic SUP paddle

PATENTED

Telescopic paddle in FIBERGLASS shaft with blade injected with gas assist injection which permits to have a rigidity and a low weight. Blade in reinforced polypropylene. It's possible to have blade color personalized.

玻纤杆伸缩桨，使用气辅成型科技注塑而成的桨叶既保证了坚硬度也保证了一个较轻的重量。桨叶由增强聚丙烯制成。可以按照要求定制桨叶颜色。

## Features:

- adjustable length from 164 to 218cm
- light and FLOATING, 1020g
- shaft of 31 and 28mm in fiberglass with reinforced ring
- compact: removable in 3 parts of 79cm

## 特性:

- 长度可在164到218cm之间调节
- 重量轻且上浮，1020g
- 桨杆由31及28mm的玻纤杆组成，有横向加强圈
- 紧凑：可拆卸成3截，总长79cm



# PS5

## ALU telescopic SUP paddle

Telescopic paddle in aluminum shaft with NEW blade injected with the gas assist injection which permits to keep a good rigidity and a low weight. The shaft is in aluminum and anodized in natural color, it's possible to make the shaft in black anodizing. Blade in reinforced polypropylene and rapid hook in reinforced nylon. It's possible to have blade color personalized.

铝桨杆伸缩桨，使用气辅成型科技注塑而成的桨叶既保证了坚硬度也保证了一个较轻的重量。桨杆是自然色氧化铝管，可以按照要求做成黑色氧化。桨叶由增强聚丙烯制成，快速卡扣由增强尼龙制成。可以按照要求定制桨叶颜色。

### Features:

- adjustable length from 153 to 218cm
- light and FLOATING, 950g
- shaft of 29 and 26.5mm in alloy 6005-T6
- compact: removable in 3 parts of 79cm

### 特性:

- 长度可在153-218cm之间调节
- 重量轻且上浮，950g
- 桨杆由29及26.5mm的6005-T6铝杆组成
- 紧凑：可拆卸成3截，总长79cm



Blade  
580 cm<sup>2</sup>

# PS6

## ALU telescopic SUP paddle KIDS

Telescopic paddle in aluminum shaft for kids, with the same technical features of PS5.

儿童用铝桨杆伸缩桨，技术特点同PS5

### Features:

- adjustable length from 133 to 185cm
- light and FLOATING, 900g
- shaft of 29 and 26.5mm in alloy 6005-T6
- compact: removable in 3 parts of 68cm

### 特性:

- 长度可在133-185cm之间调节
- 重量轻且上浮，900g
- 桨杆由29及26.5mm的6005-T6铝杆组成
- 紧凑：可拆卸成3截，总长68cm

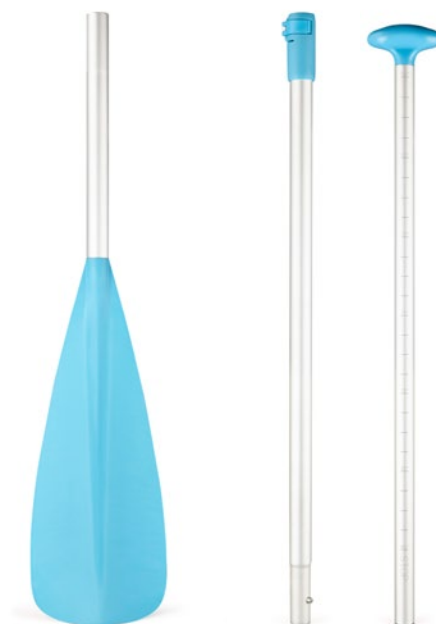

# PS7

ALU telescopic  
SUP/KAYAK paddle - COMBO

Same features as paddle PS5, but with an addition blade in order to transform it to KAYAK paddle. The length transforming into KAYAK is 198cm and the blade can be rotated 360°.

特性同PS5，但是多一个桨叶，以便于转换成皮划艇桨。转换成皮划艇桨后的长度是198cm，桨叶可以360°旋转。



# PSH

FIBER telescopic SUP paddle

Telescopic paddle in FIBERGLASS shaft with NEW blade injected with the gas assist injection which permits to keep a good rigidity and a low weight. Blade in reinforced polypropylene and rapid hook in reinforced nylon. It's possible to have blade color personalized.

玻纤桨杆伸缩桨，使用气辅成型科技注塑而成的桨叶既保证了坚硬也保证了一个较轻的重量。桨叶由增强聚丙烯制成，快速卡扣由增强尼龙制成。可以按照要求定制桨叶颜色。

## Features:

- adjustable length from 164 to 218cm
- light and FLOATING, 900g
- shaft of 29 and 26.5mm in fiberglass with reinforced ring
- Compact: removable in 3 parts of 79cm

## 特性:

- 长度可在164-218cm之间调节
- 重量轻且上浮，900g
- 桨杆由29及26.5mm的6005-T6铝杆组成
- 紧凑：可拆卸成3截，总长79cm



# PS8

## BASIC ALU telescopic SUP paddle

Telescopic paddle in aluminium shaft with NEW blade in nylon with fiberglass which permits to keep a good rigidity and a low weight. The shaft is in aluminium and anodized in natural colour, it's possible to make the shaft in black anodizing. Blade and rapid hook in reinforced nylon. It's possible to have blade colour personalized.

铝桨杆伸缩桨，新款增强尼龙桨叶，既保证了坚硬度也保证了一个较轻的重量。桨杆是自然色氧化铝管，可以按照要求做成黑色氧化。快速卡扣由增强尼龙制成。可以按照要求定制桨叶颜色。

### Features:

- adjustable length from 153 to 218cm
- light and FLOATING, 950g
- shaft of 29 and 26.5mm in alloy 6005-T6
- compact: removable in 3 parts of 79cm

### 特性:

- 长度可在153-218cm之间调节
- 重量轻且上浮，950g
- 桨杆由29及26.5mm的6005-T6铝杆组成
- 紧凑：可拆卸成3截，总长79cm



Blade  
650 cm<sup>2</sup>

# PS9

## BASIC ALU telescopic SUP/KAYAK paddle - COMBO

Same features as paddle PS8, but with an addition blade in order to transform it to KAYAK paddle. The length transforming into KAYAK is 198cm and the blade can be rotated 360°.

特性同PS8，但是多一个桨叶，以便于转换成皮划艇桨。转换成皮划艇桨后的长度是198cm，桨叶可以360°旋转。





# GM1

gauge meter adapter

PATENTED

Gauge meter Adapter for valve type HR or similar, completely customizable for calibration, graphic and color. Accurate, compact and economical. Calibration for boat, kayak, tent and SUP as per require.

适用于HR或类似阀门的压力表接头，完全可以按照要求定制压力表的量程，图像及颜色。精确，紧凑并经济。有很多适用于船，皮划艇，帐篷，风筝及SUP板的量程可用。

## Features:

- shockproof and floating
- it's possible to create adapters for other type of valves (Leaffield, Boston, etc.) as per require

## 特性:

- 防爆并上浮
- 可按要求做适用于其他阀门（如Leaffield, Boston等）的接头



# RV1

relief valve

PATENTED

It's ideal for any application while there's high risk of contamination and necessary to have a relief valve very compact, accurate and robust. The very fine filter of 90 microns doesn't compromise the airflow of the valve.

对于很有可能被搞脏及有必要用到一款紧凑、精确及牢固的安全阀的应用来说，这是一款非常理想的安全阀。90微米的极细滤网不会影响到阀门放气的流量。

## Features:

- calibration per boat, kayak, tent and SUP as per require
- all the material and components are UV resistance, the gasket is in high quality silicon
- body with stainless steel filter, ferrule with mesh filter
- test 100% in opening and closing
- dimension: Ø 47xH32mm, Ø thread 24mm

## 特性:

- 按照要求有适用于船，皮划艇，帐篷及SUP板的量程
- 所有的材料和零件都抗紫外，垫圈是高质量的硅胶
- 主体带不锈钢滤网，下盖外包有滤网布
- 开启及关闭点100%全检
- 尺寸：直径47x高度32mm。螺纹直径24mm。



# V1 boat valve

(code black : V1001 / code grey : V1002)

PATENTED

This valve is designed to be used in all inflatable fields, where the tubulars are mono-coated or bi-coated. It's the best for boat, kayak and inflatable PVC tent.

这个气阀可用于所有的充气行业，不管气囊是单层面料还是双层的。最适用于船，SUP板和PVC充气帐篷。

## Features:

- open-close in push-push system
- all the material and components are UV resistance, the gasket is in high quality silicon
- ferrule with built-in filter for elevate air flow
- test 100%
- dimension:  $\varnothing$  60xH42mm,  $\varnothing$  thread 38mm

## 特性:

- 开启-关闭采用圆珠笔式按压
- 所有的材料和零件都抗紫外，垫圈是高质量的硅胶
- 下盖内嵌滤网，可保证高气流量
- 100%全检
- 尺寸：直径60x高度42mm。螺纹直径38mm。



# V4 boat valve

(code black : V4001 / code grey : V4002)

PATENTED

Same features as valve V1, but use the classical open-close system PUSH-TURN.

特性同V1，但是采用经典的按下-旋转的开启关闭方式。

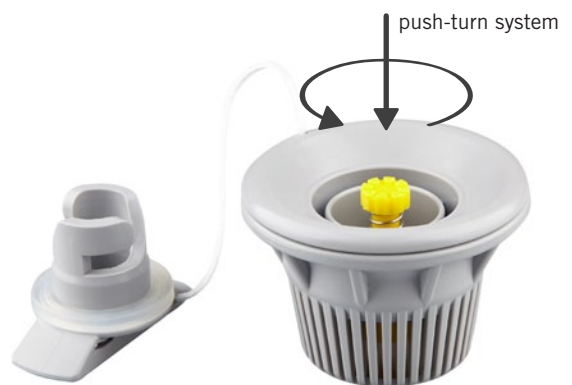

# V3 SUP valve

(code black : V3001 / code grey : V3002)

PATENTED

This valve is designed to be used with drop stitch material, in fact its thin and robust filter on the ferrule blocks the stitches inside board entering the valve. It's the best for kayak and SUP board.

这个阀门是为使用拉丝线为面料的产品而设计的，细小而牢固的滤网可以防止板子内部的拉丝进入到阀门内部。最适合用于皮划艇及SUP板。

## Features:

- open-close in push-push system
- all the material and components are UV resistance, the gasket is in high quality silicon
- ferrule with mesh filter
- test 100%
- dimension: Ø 60xH42mm, Ø thread 38mm

## 特性:

- 开启-关闭采用圆珠笔式按压
- 所有的材料和零件都抗紫外，垫圈是高质量的硅胶
- 下盖外包有滤网布
- 100%全检
- 尺寸：直径60x高度42mm。螺纹直径38mm。

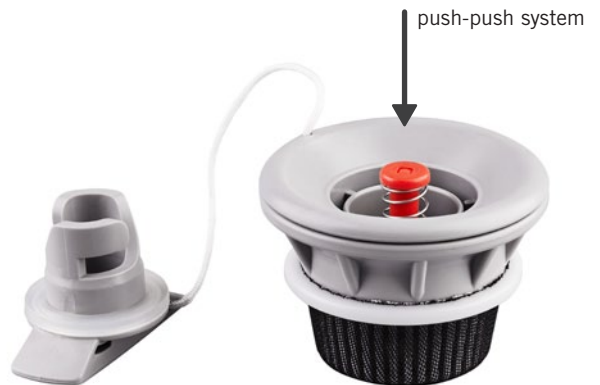

# V5 SUP valve

(code black : V5001 / code grey : V5002)

PATENTED

Same features as valve V3, but use the classical open-close system PUSH-TURN.

特性同V3，但是采用经典的按下-旋转的开启关闭方式。



# V6

## SUP valve

(code black : V6001 / code grey : V6002)

PATENTED

This valve is designed to be used not only with drop stitch material, but also with mono/bi fabric. It is very compact, hence the hole on board to assemble this valve can be very small. It's the best choice for SUP board, kayak, boat and inflatable tent.

这个阀门的设计初衷，不仅仅是为了拉丝面料，也适用于单层或复合面料。阀门很紧凑，因此板上装阀门的开口也可以很小。最适用于桨板，皮划艇，充气船及充气帐篷。

### Features:

- open-close in push-turn system
- all the material and components are UV resistance, the gasket is in high quality silicon
- ferrule with built-in filter for elevate air flow
- test 100%
- dimension:  $\varnothing$  50xH41mm,  $\varnothing$  thread 30mm

### 特性:

- 开启-关闭采用经典的按下-旋转的方式
- 所有的材料和零件都抗紫外，垫圈是高质量的硅胶
- 下盖内嵌滤网，可保证高气流量
- 100%全检
- 尺寸：直径50x高度41mm。螺纹直径30mm。



# KEY2

## key for valve

(code : Key02)

Tightening wrench reinforced in nylon for valves V4, V5, V6 and HR or similar.

增强尼龙制成的阀门扳手，用于V4, V5, V6和 HR及类似阀门



# V2 KITE surf valve

(code black : V2001)

PATENTED

This valve is designed to be used in all inflatable fields, where the tubulars are made up of PU bladder and external sheath. Push-push opening, very elevate air flow, easy to be assembled.

这个气阀可用于所有气囊是由PU内层和外部套管组成的充气行业。圆珠笔式按压开启-关闭方式，高气流量，易安装。

## Features:

- open-close in push-push system
- PVC base can be welded to PU bladder. The valve body retains the external sheath
- all the material and components are UV resistance, the gasket is in high quality silicon
- test 100%
- dimension valve  $\varnothing$  45xH29mm, dimension PVC base  $\varnothing$  72xH34mm

## 特性:

- 开启-关闭采用圆珠笔式按压
- PVC底座，可焊接到PU内层。阀门主体卡住外部套管
- 所有的材料和零件都抗紫外，垫圈是高质量的硅胶
- 100%全检
- 阀门主体尺寸：直径45x高度29mm。PVC底座尺寸：直径72x高度34mm



# KEY1 key for valve

(code : Key01)

Tightening wrench reinforced in nylon for valves V1, V2, V3 and RV1.

增强尼龙制成的阀门扳手，用于V1, V2, V3及RV1



# FN1

removable fin

(code black : FN104)

PATENTED

Central and side fins made in reinforced nylon and shock-proof ABS. Compact and robust. Equipped with quick hook-release system which is patented. Color can be personalized based on require.

Dimension FN1 : 280x100x220mm

中央鳍片及边鳍由增强尼龙及防爆ABS制成。紧凑并牢固。配备快速释放制动系统，并已获得专利。颜色可以按照要求定制。

产品尺寸 FN1: 280x100x220mm



TPU version fin is available  
鳍片也可以是TPU材质

Patented quick hook-release system



# FN4

removable fin

(code black : FN401)

PATENTED

Central and side fins made in reinforced nylon and shock-proof ABS. Compact and robust. Equipped with quick hook-release system which is patented. Color can be personalized based on require.

Dimension FN4 : 180x75x140mm

中央鳍片及边鳍由增强尼龙及防爆ABS制成。紧凑并牢固。配备快速释放制动系统，并已获得专利。颜色可以按照要求定制。

产品尺寸 FN4: 180x75x140mm



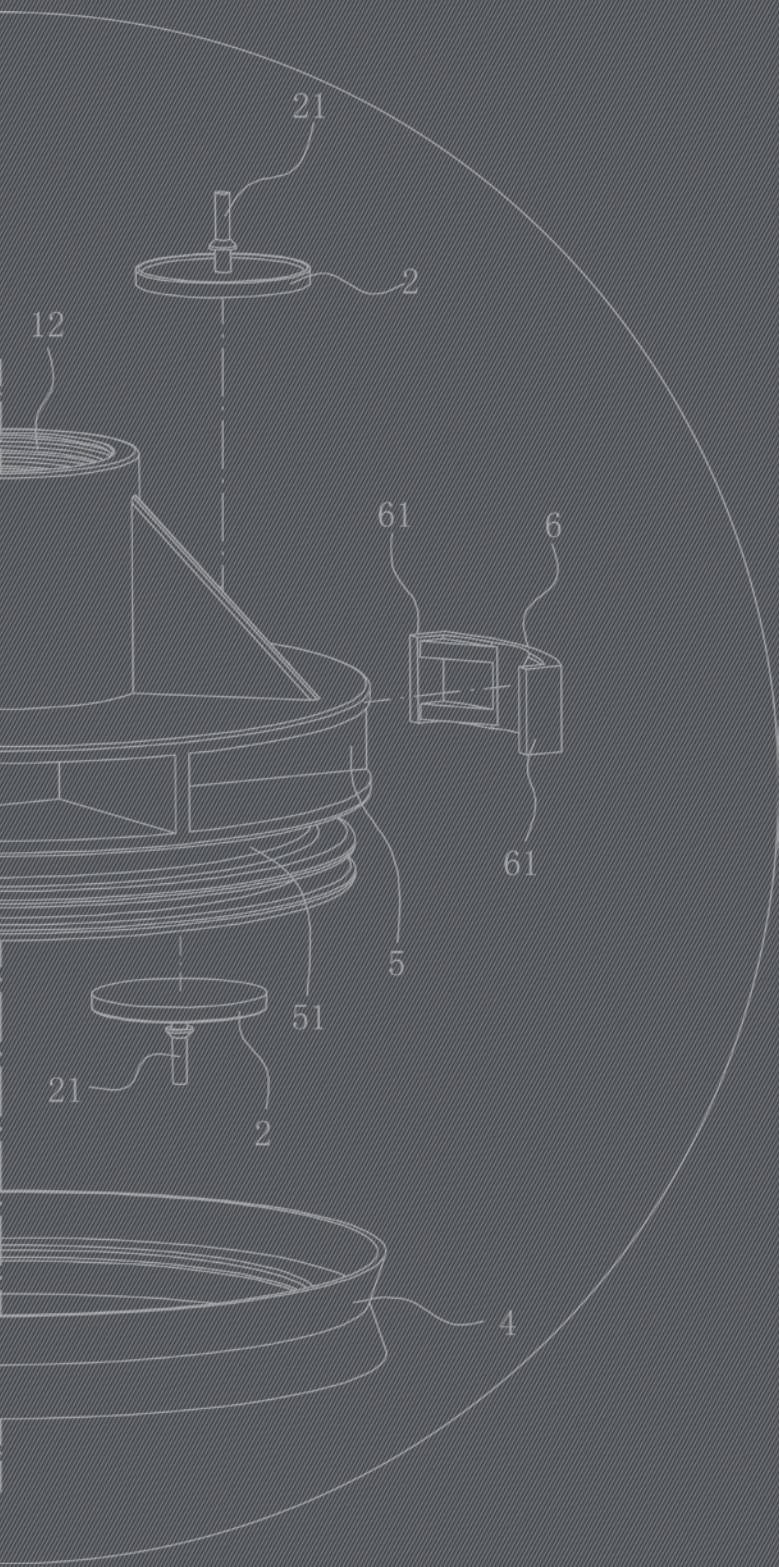

PATENTED by 

US 10,041,485 B2	ZL 2015 3 0293383. 1
ZL 2014 1 0330801. 4	ZL 2015 3 0333843. 9
ZL 2014 2 0384139. 6	ZL 2015 2 0674874. 5
ZL 2014 2 0387107. 1	ZL 2015 2 0672621. 4
ZL 2014 2 0387110. 3	ZL 2015 3 0333713. 5
ZL 2014 2 0403847. X	ZL 2015 2 0881815. 5
ZL 2014 3 0247075. 0	ZL 2015 3 0542084. 7
ZL 2014 3 0246918. 5	ZL 2015 3 0542073. 9
ZL 2014 3 0233648. 4	ZL 2016 2 0049710. 8
ZL 2014 3 0233620. 0	ZL 2016 2 1286831. 0
ZL 2014 1 0333280. 8	ZL 2017 2 0944862. 9
ZL 2014 1 0344095. 9	ZL 2017 2 1024792. 1
ZL 2014 2 0399324. 2	ZL 2018 1 0425600. 0
ZL 2014 2 0405490. 9	ZL 2018 2 0672112. 5
ZL 2014 1 0623357. 5	ZL 2018 1 0487864. 9
ZL 2014 2 0660484. 8	ZL 2018 2 0758836. 1
ZL 2014 2 0711166. X	ZL 2018 2 0856902. 9
ZL 2014 1 0748677. 3	ZL 2018 1 0907125. 0
ZL 2014 2 0769644. 2	ZL 2018 2 1292664. X
ZL 2015 1 0476721. 4	ZL 2019 2 0480895. 1
ZL 2015 2 0588358. 0	ZL 2019 3 0377895. 4



ADVANCED TECHNOLOGY AND INNOVATION FOR WATER SPORT

Ningbo Jing Quan Import and Export Co.,Ltd.  
宁波景铨进出口有限公司

Yuyao Ermanno Plastic Technology Co.,Ltd.  
余姚爱玛诺塑料科技有限公司

Operative Add.: No.2, Jingtou Village, Sanqishi Town, Yuyao, Zhejiang, China, 315412  
办公地址：浙江省余姚市三七市镇井头村2号 315412

Tel.: +86 574 62925093 / +86 574 62925756

Fax: +86 574 62925092 - Cell. : +86 13566312909

[www.j-quan.com](http://www.j-quan.com) - [sales@j-quan.com](mailto:sales@j-quan.com)

